

VALVES SERIES 70, SOLENOID/PNEUMATIC

TECHNICAL DATA	1/8"	1/4"	1/2"
Operating pressure:	2.5 bar ÷ 10 bar		
	1 ÷ 10 bar		
	Vacuum ÷ 10		
Minimum actuation pressure	2.5 bar		
Operating temperature range	-10° to 60°C		
Nominal diameter	5 mm	7.5 mm	15 mm
Conductance C [NI/min · bar]	121.43	264.26	971.43
Critical ratio b	0.32 bar/bar	0.27 bar/bar	0.43 bar/bar
Flow rate at 6 bar ΔP 0.5 bar	400 NI/min	750 NI/min	3200 NI/min
Flow rate at 6 bar ΔP 1 bar	550 NI/min	1100 NI/min	4600 NI/min
TRA/TRR monostable at 6 bar	15 ms / 35 ms	19 ms / 45 ms	36 ms / 60 ms
TRA /TRR bistable at 6 bar	20 ms / 20 ms	21 ms / 21 ms	30 ms / 30 ms
Hand operation	bistable		
Coil voltage values	24VDC ÷ 24VAC ÷ 110VAC ÷ 220VAC 50/60Hz		
Power	2 W (DC) 3VA (AC) 2 W (DC) 3VA (AC) 5W (DC) 5VA (AC)		
Voltage tolerance	-10% ÷ +15%		
Insulation class	F 155		
Maximum coil nut torque	1 Nm		

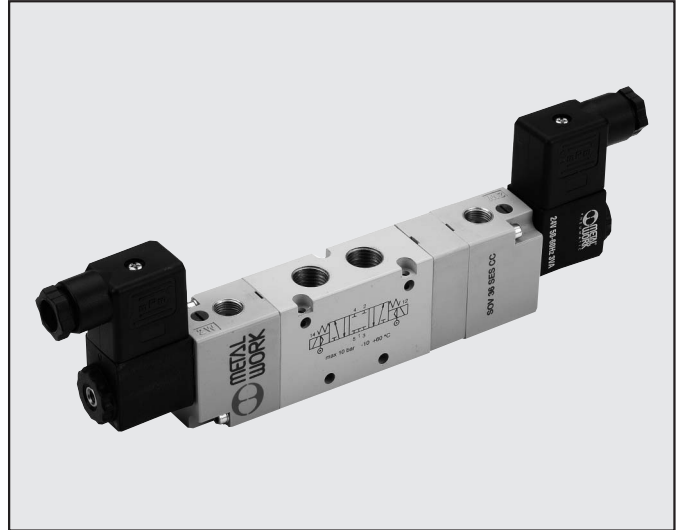

KEY TO CODES

S	O	V	2	3	S	O	S	N	C		
FAMILY		PORT		FUNCTION		OPERATORS 14		RESETTING 12		FURTHER DETAILS	
SOV	Solenoid / pneumatic	2	1/8"	3	3/2	SO	Solenoid	S	mechanical spring	NC	normally closed
		3	1/4"	5	5/2	SE	Solenoid assisted	B	bistable	NO	normally open
		4	1/2"	6	5/3			D	differential pneumatic*	CC	closed centres
								P	pneumatic/mechanical spring*	OC	open centres
								A	on demand	PC	pressure centres
										OO	5/2

VALVES SERIES 70, SOLENOID/PNEUMATIC-PILOT-ASSISTED SOLENOID/PNEUMATIC, 1/8"

MONOSTABLE 3/2 NO, 1/8"

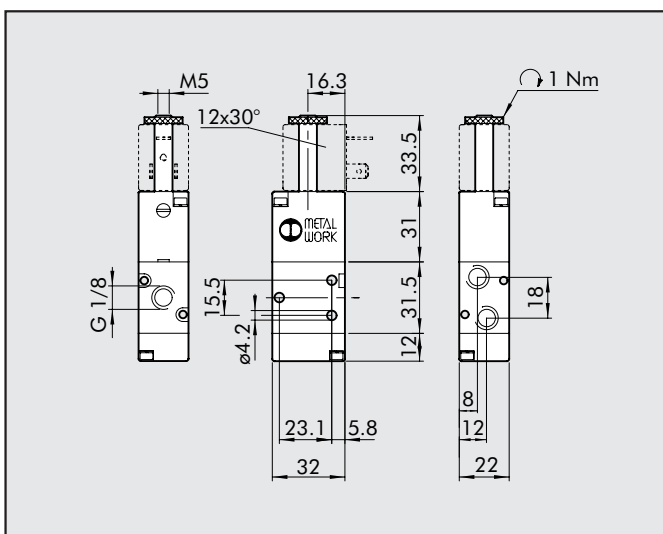

Symbol	Abbrev.	Code	Weight [g]
	SOV 23 SOS NO	7010020400	100

MONOSTABLE 3/2 NC, 1/8"

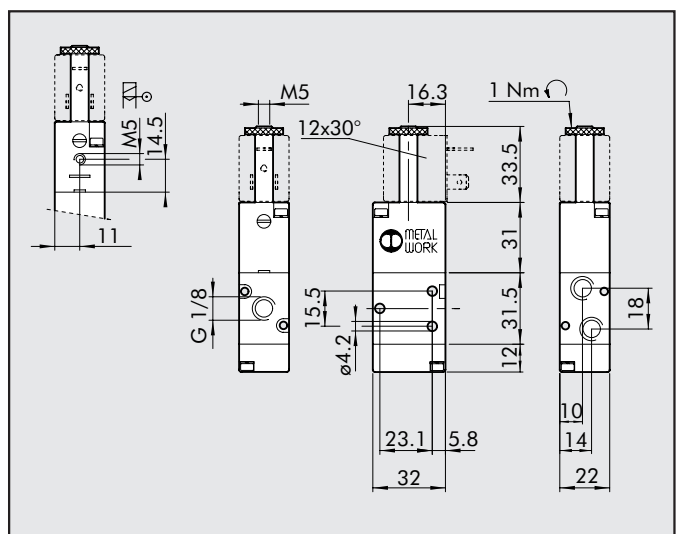

Symbol	Abbrev.	Code	Weight [g]
	SOV 23 SOS NC	7010020200	100
	SOV 23 SES NC	7010020500	100

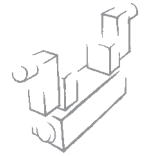

MONOSTABLE 5/2, 1/8"

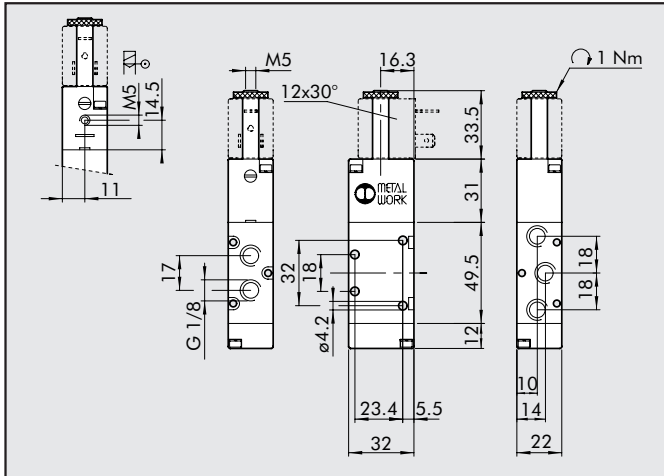

Symbol	Abbrev.	Code	Weight [g]
	SOV 25 SOS OO	7010021100	128
	SOV 25 SES OO	7010021500	129

BISTABLE 5/2, 1/8"

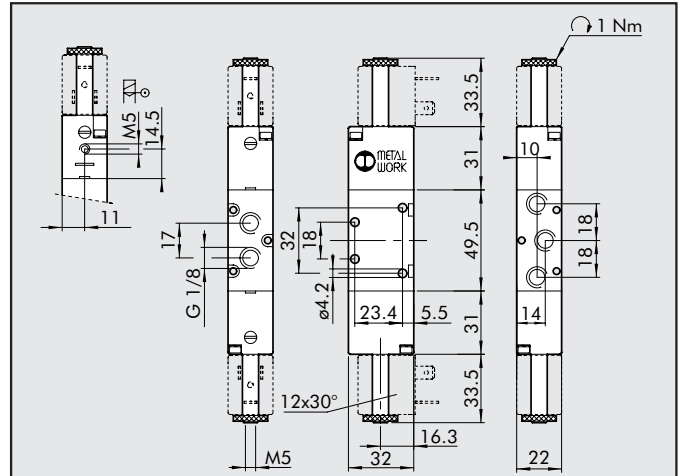

Symbol	Abbrev.	Code	Weight [g]
	SOV 25 SOB OO	7010021200	160
	SOV 25 SOD OO	7010021300	166
	SOV 25 SEB OO	7010021600	160

BISTABLE 3/2, 1/8"

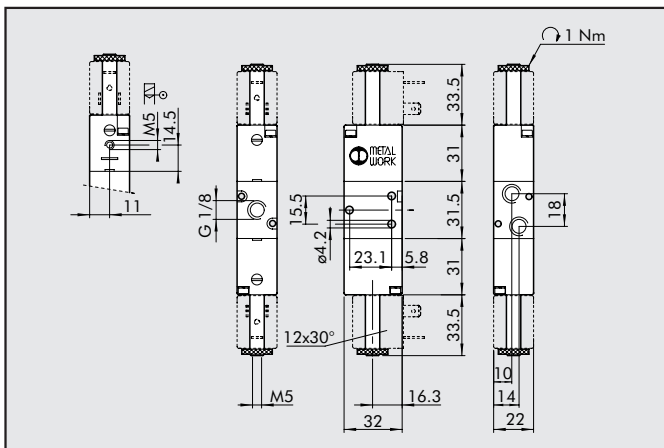

Symbol	Abbrev.	Code	Weight [g]
	SOV 23 SOB OO	7010020100	135
	SOV 23 SEB OO	7010020300	136

MONOSTABLE 5/3, 1/8"

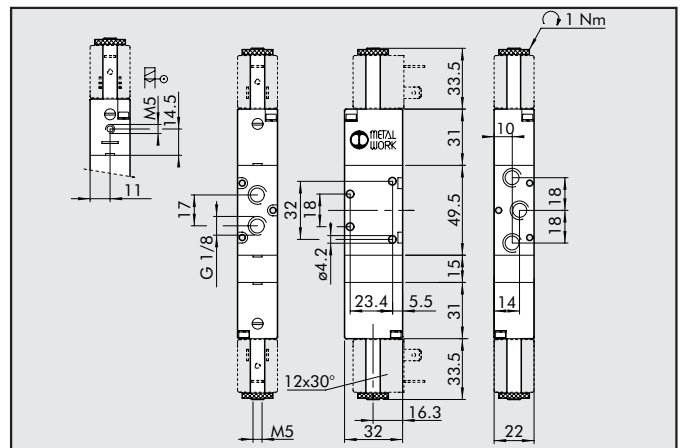

Symbol	Abbrev.	Code	Weight [g]
	SOV 26 SOS CC	7010022100	190
	SOV 26 SOS OC	7010022200	190
	SOV 26 SOS PC	7010022300	190
	SOV 26 SES CC	7010022400	188
	SOV 26 SES OC	7010022500	188
	SOV 26 SES PC	7010022600	188

VALVES SERIES 70, SOLENOID/PNEUMATIC-PILOT-ASSISTED SOLENOID/ PNEUMATIC, 1/4"

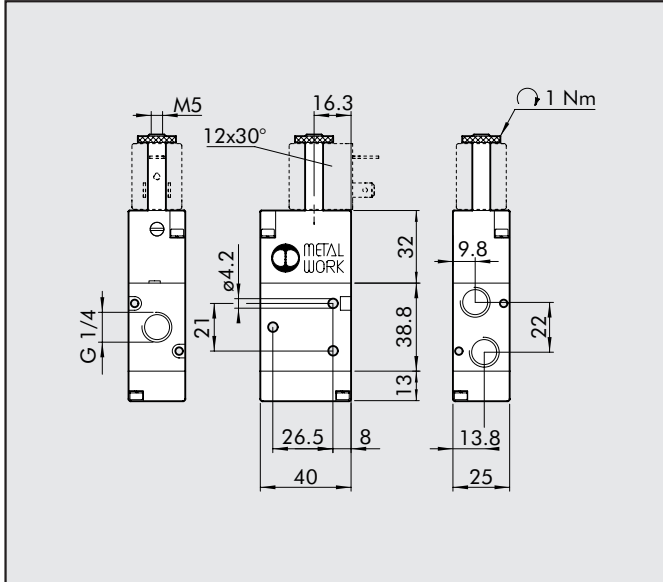

MONOSTABLE 3/2 NO, 1/4"

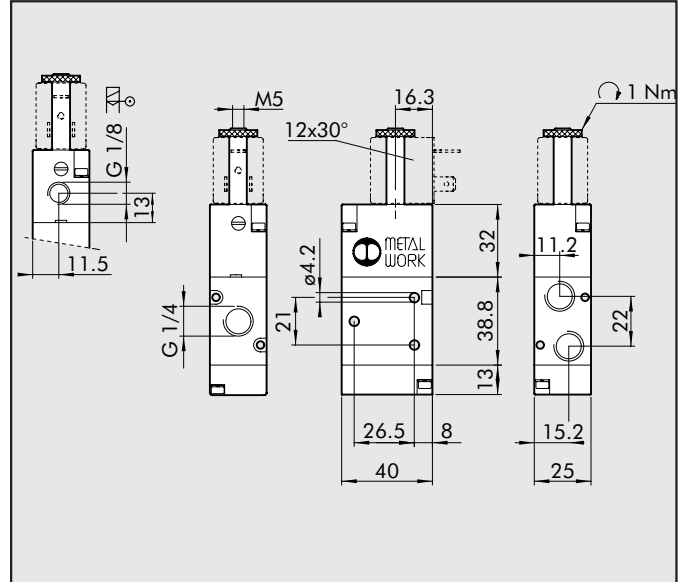

Symbol	Abbrev.	Code	Weight [g]
	SOV 33 SOS NO	7020020400	152

MONOSTABLE 3/2 NC, 1/4"



Symbol	Abbrev.	Code	Weight [g]
	SOV 33 SOS NC	7020020200	152
	SOV 33 SES NC	7020020500	152

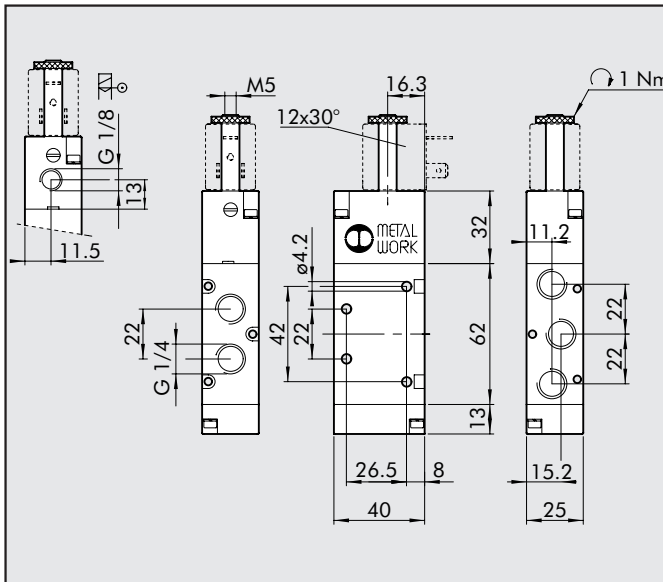

5/2 1/4" MONOSTABLE

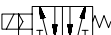

Symbol	Abbrev.	Code	Weight [g]
	SOV 35 SOS OO	7020021100	200
	SOV 35 SES OO	7020021500	200

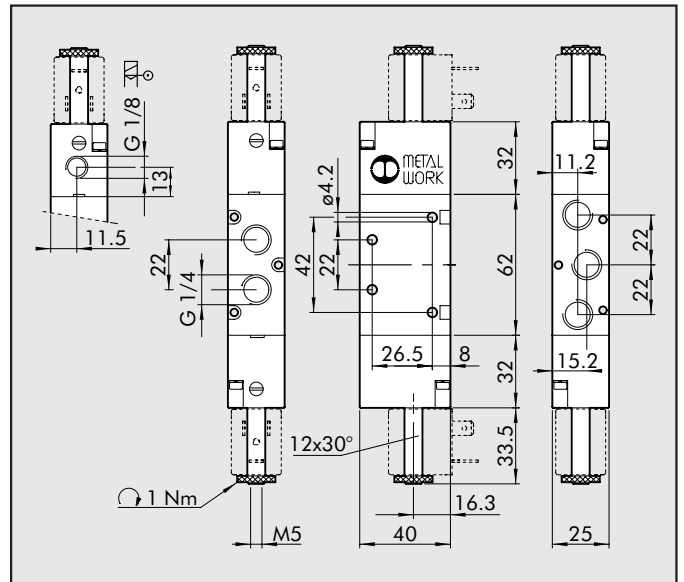
5/2 1/4" BISTABLE

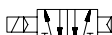

Symbol	Abbrev.	Code	Weight [g]
	SOV 35 SOB OO	7020021200	236
	SOV 35 SOD OO	7020021300	252
	SOV 35 SEB OO	7020021600	242

VALVES SERIES 70, SOLENOID/PNEUMATIC-PILOT-ASSISTED SOLENOID/PNEUMATIC, 1/2"

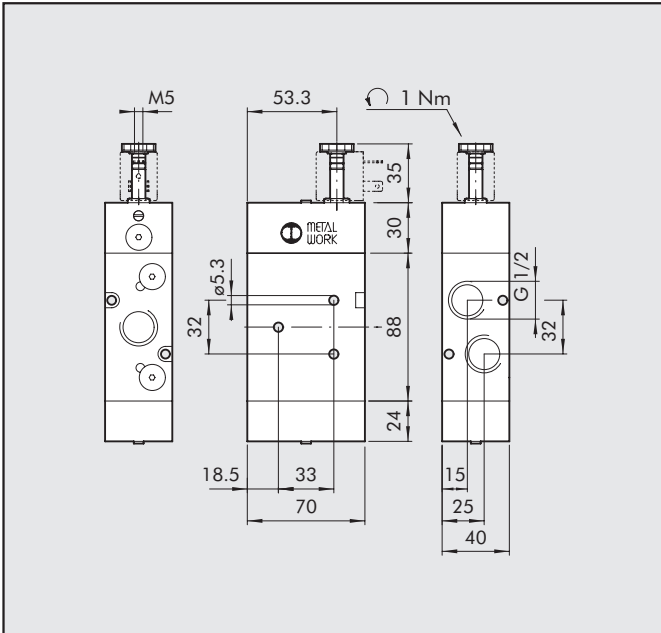

MONOSTABLE 3/2 NO, 1/2"

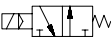

Symbol	Abbrev.	Code	Weight [g]
	SOV 43 SOS NO	7030020400	930

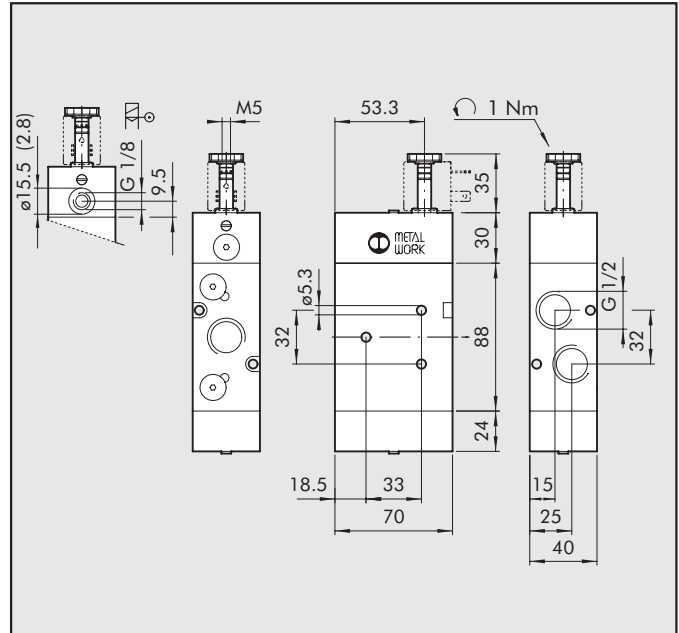

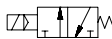
MONOSTABLE 3/2 NC, 1/2"



Symbol	Abbrev.	Code	Weight [g]
	SOV 43 SOS NC	7030020200	930
	SOV 43 SES NC	7030020500	923

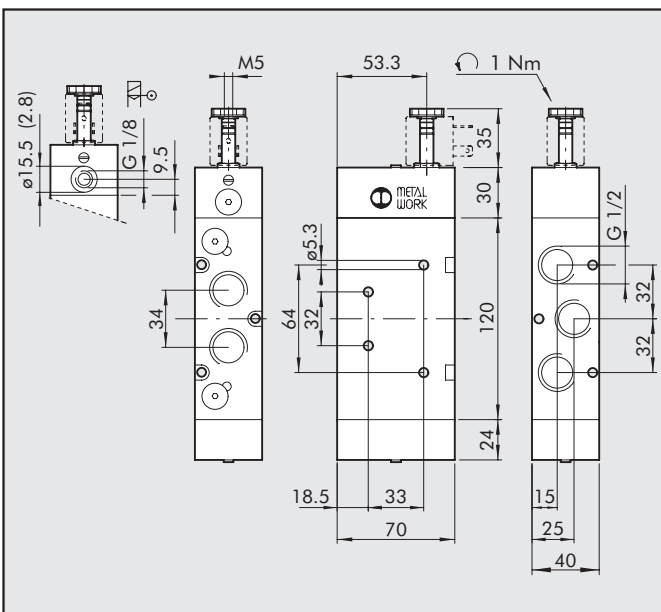

MONOSTABLE 5/2, 1/2"

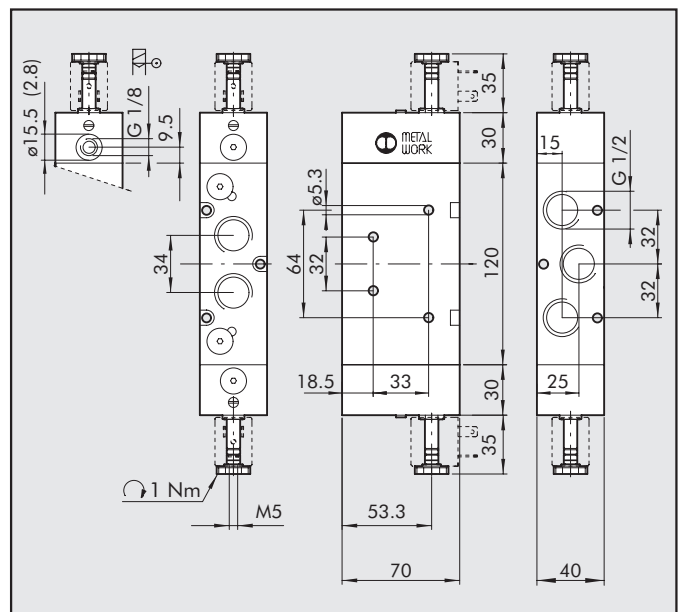

Symbol	Abbrev.	Code	Weight [g]
	SOV 45 SOS OO	7030021100	1120
	SOV 45 SES OO	7030021500	1113

BISTABLE 5/2, 1/2"



Symbol	Abbrev.	Code	Weight [g]
	SOV 45 SOB OO	7030021200	1140
	SOV 45 SOD OO	7030021300	1152
	SOV 45 SEB OO	7030021600	1127

